

# KE ARMONY PLUS B40

per aumenti TESSUTO e RAL vedi pagine 108/116  
 For fabric and RAL increases see at pages 108/116  
 Augmentation TISSU et RAL voir pages 108/116  
 Für Aufpreise für RAL und Stoffe S. seiten 108/116



Sistema ribaltabile  
 Tipping system  
 Systeme rebaltable  
 Kippsystem

Salvatessuto in PVC su tutta la lunghezza  
 PVC Fabric protection for the whole awning width  
 Profil PVC pour protection tissu  
 inneres Schutzprofil aus PVC für die ganze Länge

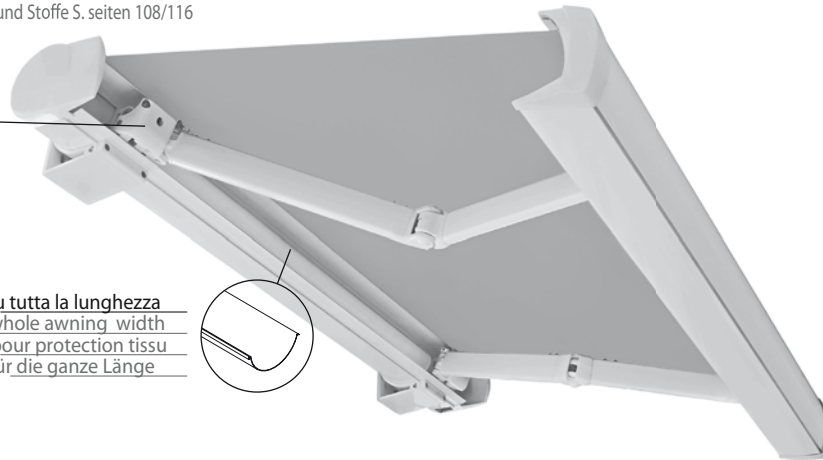

Montaggio a parete  
 Wall installation

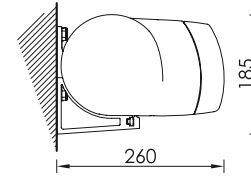

Montaggio a parete con terminale a cassettono  
 Wall installation with box terminal bar



Diagramma di copertura a parete - Wall covering diagram



- Bracci / Arms / Bras / Arme
- ▶ Kit convogliatore / Kit conveyer / Kit convoyeur / Satz Konveyer
- Supporto bracci-staffa parete-soffitto / Arm support-wall - Supports de bras / Bride mur-plafond / Armkonsolen/wand-/deckenhaltebügel

Ingombri minimi della tenda finita - 1 coppia bracci SPIN  
 Minimum awning encumbrances - 1 pair SPIN arms  
 Encombrentes minimum du store fini - 1 pair bras SPIN  
 Minimaler Ausmaß der fertigen Markise - 1 Paar Arme SPIN

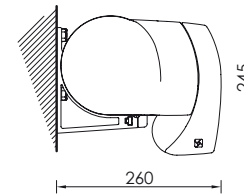
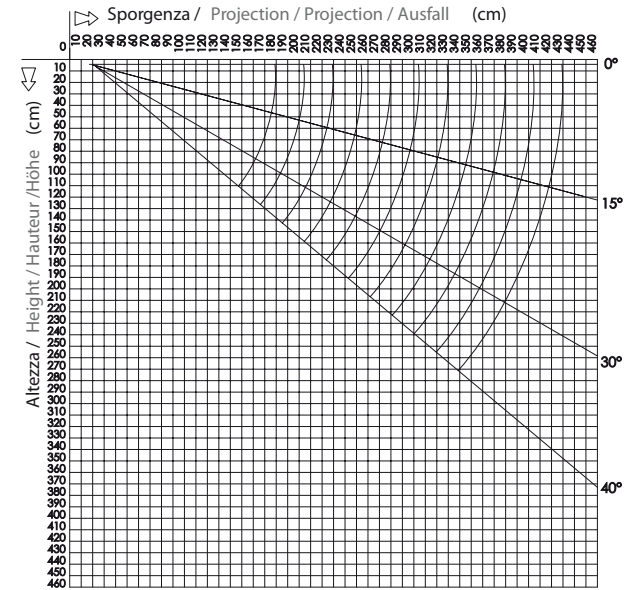
cm	↔	400	500	600	700	800	900	1000	1100	1200
160	■	2	2	4	4	4	4	6	6	6
	▶	1	1	1	1	1	1	1	1	1
	●	2	2	4	4	4	4	6	6	6
185	■	2	2	4	4	4	4	6	6	6
	▶	1	1	1	1	1	1	1	1	1
	●	2	2	4	4	4	4	6	6	6
210	■	2	2	4	4	4	4	6	6	6
	▶	1	1	1	1	1	1	1	1	1
	●	2	2	4	4	4	4	6	6	6
235	■	2	2	4	4	4	4	6	6	6
	▶	1	1	1	1	1	1	1	1	1
	●	2	2	4	4	4	4	6	6	6
260	■	2	2	3	4	4	4	6	6	6
	▶	1	1	1	1	1	1	1	1	1
	●	2	2	3	4	4	4	6	6	6
310	■	2	2	3	3	4	4	5	6	6
	▶	1	1	1	1	1	1	1	1	1
	●	2	2	3	3	4	4	5	6	6
360	■	-	2	2	3	3	4	4	5	5
	▶	-	1	1	1	1	1	1	1	1
	●	-	2	2	3	3	4	4	5	5
410	■	-	2	2	2	3	3	4	4	5
	▶	-	1	1	1	1	1	1	1	1
	●	-	2	2	2	3	3	4	4	5

cm	↔
160	212
185	237
210	262
235	287
260	312
310	374
360	424
410	474

Montaggio a soffitto  
 Ceiling installation

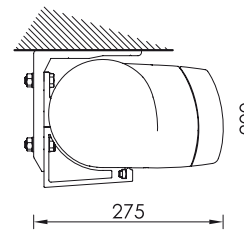

Montaggio a soffitto con terminale a cassettono  
 Ceiling installation with box terminal bar

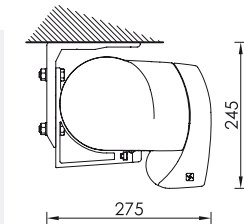

Diagramma di copertura a soffitto - Ceiling covering diagram

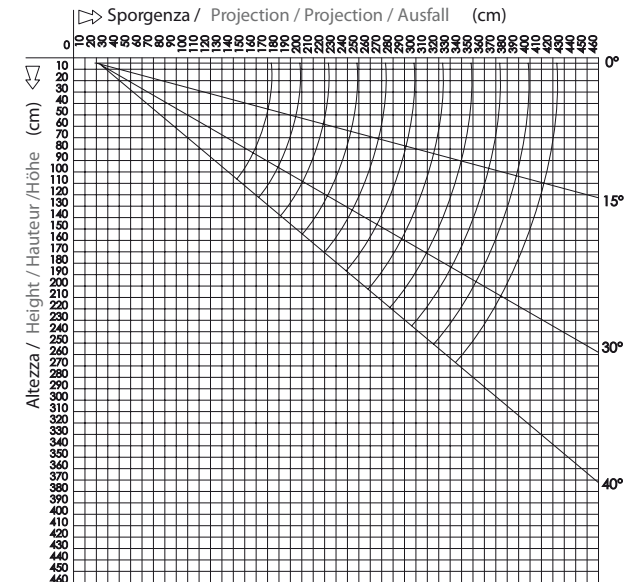

Tutte le misure dei montaggi sono espresse in mm \ All the sizes are in mm \  
 Tout dimension en mm \ Alle Massen in den Montagenschemen verstehen sich in mm